



Audio Control Center



C45 Owner's Manual

The lightning flash with arrowhead, within an equilateral triangle, is intended to alert the user to the presence of uninsulated “dangerous voltage” within the product’s enclosure that may be of sufficient magnitude to constitute a risk of electric shock to persons.



AVIS RISQUE DE CHOC ELECTRIQUE - NE PAS OUVRIR.

The exclamation point within an equilateral triangle is intended to alert the user to the presence of important operating and maintenance (servicing) instructions in the literature accompanying the appliance.

WARNING - TO REDUCE RISK OF FIRE OR ELECTRICAL SHOCK, DO NOT EXPOSE THIS EQUIPMENT TO RAIN OR MOISTURE.

NO USER-SERVICEABLE PARTS INSIDE. REFER SERVICING TO QUALIFIED PERSONNEL.

To prevent the risk of electric shock, do not remove cover or back. No user serviceable parts inside.

IMPORTANT SAFETY INSTRUCTIONS!

PLEASE READ THEM BEFORE OPERATING THIS EQUIPMENT.

1. Read these instructions.
2. Keep these instructions.
3. Heed all warnings.
4. Follow all instructions.
5. Do not use this apparatus near water.
6. Clean only with a dry cloth.
7. Do not block any ventilation openings. Install in accordance with the manufacturer’s instructions.
8. Do not install near any heat sources such as radiators, heat registers, stoves, or other apparatus (including amplifiers) that produce heat.
9. Do not defeat the safety purpose of the polarized or grounding-type plug. A polarized plug has two blades with one wider than the other. A grounding type plug has two blades and a third grounding prong. The wide blade or the third prong are provided for your safety. If the provided plug does not fit into your outlet, consult an electrician for replacement of the obsolete outlet.
10. Protect the power cord from being walked on or pinched particularly at plugs, convenience receptacles, and the point where they exit from the apparatus.
11. Only use attachments/accessories specified by the manufacturer.
12. Use only with the cart, stand, tripod, bracket, or table specified by the manufacturer, or sold with the apparatus. When a cart is used, use caution when moving the cart/apparatus combination to avoid injury from tip-over. 
13. Unplug this apparatus during lightning storms or when unused for long periods of time.
14. Refer all servicing to qualified service personnel. Servicing is required when the apparatus has been damaged in any way, such as power-supply cord or plug is damaged, liquid has been spilled or objects have fallen into the apparatus, the apparatus has been exposed to rain or moisture, does not operate normally, or has been dropped.
15. Do not expose this equipment to dripping or splashing and ensure that no objects filled with liquids, such as vases, are placed on the equipment.
16. To completely disconnect this equipment from the a.c. mains, disconnect the power supply cord plug from the a.c. receptacle.
17. The mains plug of the power supply cord shall remain readily operable.

Thank You

Your decision to own this McIntosh C45 Audio Control Center ranks you at the very top among discriminating music listeners. You now have “The Best.” The McIntosh dedication to “Quality,” is assurance that you will receive many years of musical enjoyment from this unit.

Please take a short time to read the information in this manual. We want you to be as familiar as possible with all the features and functions of your new McIntosh.

Please Take A Moment

The serial number, purchase date and McIntosh Dealer name are important to you for possible insurance claim or future service. The spaces below have been provided for you to record that information:

Serial Number: _____

Purchase Date: _____

Dealer Name: _____

Technical Assistance

If at any time you have questions about your McIntosh product, contact your McIntosh Dealer who is familiar with your McIntosh equipment and any other brands that may be part of your system. If you or your Dealer wish additional help concerning a suspected problem, you can receive technical assistance for all McIntosh products at:

McIntosh Laboratory, Inc.
2 Chambers Street
Binghamton, New York 13903
Phone: 607-723-1545
Fax: 607-723-3636

Customer Service

If it is determined that your McIntosh product is in need of repair, you can return it to your Dealer. You can also return it to the McIntosh Laboratory Service Department. For assistance on factory repair return procedure, contact the McIntosh Service Department at:

McIntosh Laboratory, Inc.
2 Chambers Street
Binghamton, New York 13903
Phone: 607-723-3515
Fax: 607-723-1917

Table of Contents

Safety Instructions	2
Thank You and Please Take a Moment	3
Technical Assistance and Customer Service	3
Table of Contents	3
Important Information	4
Connector Information	4
Introduction	5
Performance Features	5
Dimensions	6
Installation	7
Connections	
Rear Panel Connections	8
How to Connect for Power Control	9
How to Connect for Data Control and Remote Operation	10
How to Connect for Two Channel Operation	11
How to Connect for Six Channel Operation	12
Front Panel Features	
Front Panel Controls, Displays, Push-buttons, and Switch	14
Setup	
How to Operate the Setup Mode	15
Default Settings	15
Display Brightness and Firmware Version	16
Country Code and Tune	16
Re-Title Inputs and Level Adjustments	17
6 Channel 1 and 2 Inputs	18
Balanced Input	18
2 Channel Sub	19
Power Control Triggers	19
Auto Tone	19
Remote Control Selection	20
Operation	
How to Operate the C45	21
Remote Control Push-buttons	24
How to Operate by Remote Control	25
Additional Information	
Preamplifier Specifications	26
TM1 AM/FM Tuner Module	
Introduction	27
Performance Features	27
C45 Rear Panel and RAA1 Top Panel and Antenna Connections	28
How to Connect Antenna Components	29
Tuner Operation	
How to Operate the Tuner	30
How to Optimize AM Reception	32
Additional Information	
Tuner Specifications	34
Packing Instructions	35

Important Information

1. It is recommended that a qualified professional assist you in the choice and installation of a McIntosh Audio System for your home.
2. Before making any connections to the C45, make sure that the Main POWER Switch is in the Off position. When the C45 and other McIntosh Components are in their Standby Mode the Microprocessor's Circuitry inside each component is active and communication is occurring between them. Failure to do so could result in malfunctioning of some or all of the system's normal operations.
3. The optional McIntosh TMI AM/FM Tuner Module can be added to the C45 Audio Control Center. The TMI is available from your McIntosh Dealer and can be installed at any time, usually while you wait. Refer to page 27 for additional information on the TMI.
4. The following Connecting Cable is available from the McIntosh Parts Department:
Data and Power Control Cable Part No. 170-202
 Six foot, 2 conductor shielded, with two 1/8 inch stereo mini phone plugs.
5. For additional connection information, refer to the owner's manual(s) for any component(s) connected to the C45.
6. Up to four McIntosh Sensors or Keypads can be wired in parallel for remote operation.
7. When a McIntosh WK-2 Keypad or a R649 Sensor is to be connected to the McIntosh C45 Audio Control Center that uses a RJ-45 Connector Plug instead of the "F" Coax Connector; connect the Center Conductor to Pin 1 and the Shield Conductor to Pin 2. Refer to the illustration below.

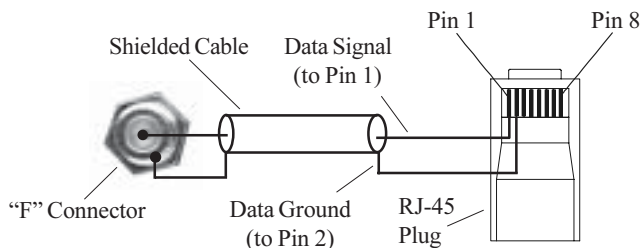

8. The Power Control Signal present at the ACC(B) Jack is controllable by either using the ACC ON or ACC OFF Push-buttons on the Remote Control or by assignment when in the Setup Mode. For additional information refer to page 19 "Power Control Triggers" in this manual.
9. Balanced and Unbalanced Inputs and Outputs can be mixed. For example, you may connect signal sources to Unbalanced Inputs and send signals from the Balanced Outputs. You can also use Balanced and Unbalanced Outputs simultaneously, connected to different Power Amplifiers.
10. Sound Intensity is measured in units called Decibels and "dB" is the abbreviation.

Connector Information

XLR Connectors

Below is the Pin configuration for the XLR Balanced Input and Output Connectors on the C45. Refer to the diagram for connection:

- PIN 1: Shield/Ground
- PIN 2: + Signal
- PIN 3: - Signal

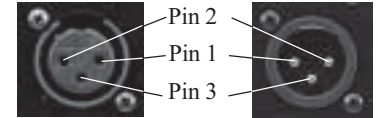

Power Control and Trigger Connectors

The C45's Power Control Outputs provide a 5 volt signal. Use a 1/8 inch stereo mini phone plug to connect to the Power Control Input on other McIntosh Components.

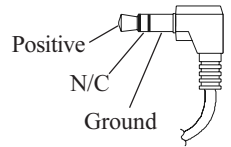

Data and IR Port Connectors

The C45's Data Port Output provides Remote Control Signals and the IR Input Port allows for the connection of other brands IR Sensors. Use a 1/8 inch stereo mini phone plug to connect to the Data Port Inputs on McIntosh Source Units.

Data Port Connector

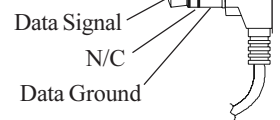

IR Input Port Connector

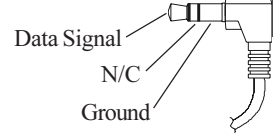

Keypad Terminal Connector

To use a WK-3 or WK-4 Keypad with the C45, connect the shield and four leads of a shielded 4 conductor cable to a RJ-45 Connector Plug, according to the numbers listed below. There is a numbered connector built-in to each Keypad, which has a different pin out.

C45 RJ-45

1. Signal Data
2. Signal Data Gnd. and Cable Shield
3. N/C
4. Supply Voltage Negative
5. Supply Voltage Positive
6. N/C
7. N/C
8. N/C

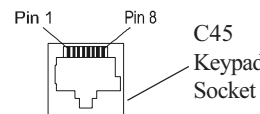

WK-3 and WK-4 Keypad

1. Supply Voltage Positive
2. Supply Voltage Negative
3. Cable Shield
4. Signal Data
5. Signal Data Gnd

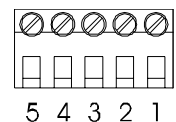

RAA1 Connector

Connect the shield and two leads of a shielded 2 conductor cable to the supplied 5 Pin Terminal Connector Plug. Refer to the connection information on the top cover of the RAA1.

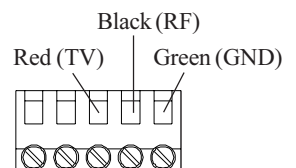

Introduction

The new McIntosh C45 Audio Control Center offers a highly refined combination of useful operating features with totally transparent electronic performance. At any time expand the enjoyment and functionality of the Audio Control Center with the addition of the optional TM1 AM/FM Tuner Module installed inside the C45. Combine a C45 with a McIntosh Power Amplifier and you will enjoy a system of unparalleled performance.

Performance Features

● **Balanced Inputs and Outputs**

One pair of Balanced high level Inputs and a six channel Balanced Output are provided.

● **Precision Tracking Variable Rate Volume Control**

Volume levels are controlled by a new Multi-Stage Precision Digitally Controlled Attenuator System with a tracking accuracy of 0.1dB. Levels change in 214 individual 0.5dB steps. The Variable Rate Volume Control Circuitry provides an ideal rate of change with control rotation.

● **Tone Control with Assignable Bypass**

The Bass and Treble Control Circuit Elements can be removed from the Signal Path of any selected input.

● **Alphanumeric Fluorescent Display**

The Multifunction Front Panel Display indicates the Source Selection and Volume Levels. The Setup Mode Selections and Adjustments are also displayed. The display intensity is fully adjustable.

● **Electromagnetic Input Switching with Level Trim Adjustment and Title Reassignment**

Digital Logic integrated circuits drive Electromagnetic Switches on all Inputs and operating functions for reliable, noiseless, distortion free switching. All eight Inputs on the C45 can be matched in level, so that there are no abrupt changes in volume levels between the different Inputs. Any of the eight Inputs can have their Input Title reassigned to match the sources in the system.

● **Power Control Output and Trigger Assignment**

A Power Control connection for convenient Turn-On of McIntosh Power Amplifiers, Source Components and Accessories is included. Two of the Power Control Outputs may be assigned to activate when a given Input is selected.

● **Multichannel Inputs**

There are two six channel Inputs that are assignable for sources such as DVD-Audio Player, Super Audio CD Player and Satellite Receivers.

● **Precision Parts**

Only the finest precision 1% tolerance resistors are used throughout.

● **Low Distortion**

Distortion levels of all types are less than 0.002%. Music is amplified with total transparency and accuracy.

● **Moving Magnet Phono Input**

There is a Precision Phono Preamplifier for Moving Magnet Cartridges.

● **Remote Control**

The C45 includes a Remote Control that allows remote operation of the Front Panel Controls and Push-buttons.

● **Optional External Keypad Sensor Input**

There are provisions for connecting External Keypad and/or Sensors, which allows for enjoyment of your McIntosh System from other room(s) in your home.

● **Subwoofer Output**

The C45 Audio Control Center provides a subwoofer output from the two channel and six channel inputs.

● **Special Power Supply**

Fully regulated Power Supply with shielded power transformer ensures stable noise free operation even if the power line should vary.

● **Fiber Optic Solid State Front Panel Illumination**

The Illumination of the Front Panel is accomplished by the combination of custom designed Fiber Optic Light Diffusers and Light Emitting Diodes (LEDs). This provides even Front Panel Illumination, together with the extra long life LEDs.

● **Glass Front Panel**

The famous McIntosh Illuminated Glass Front Panel ensures the pristine beauty of the C45 will be retained for many years.

Dimensions

The following dimensions can assist in determining the best location for your C45. There is additional information on the next page pertaining to installing the C45 into cabinets.

Front View of the C45



Rear View of the C45

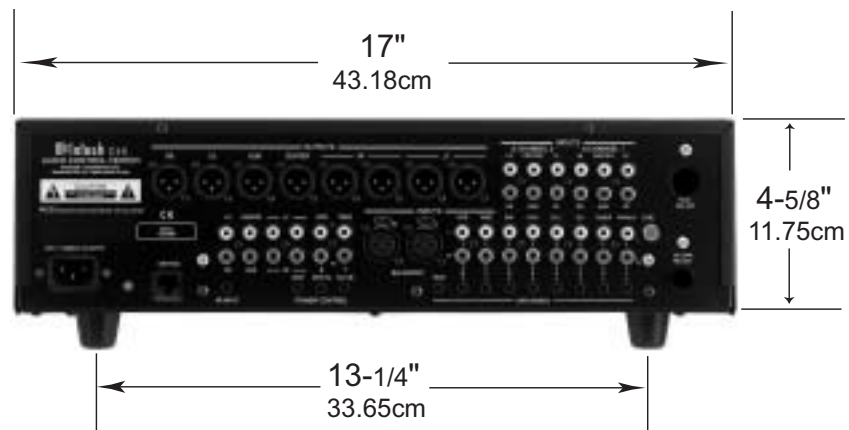

Side View of the C45

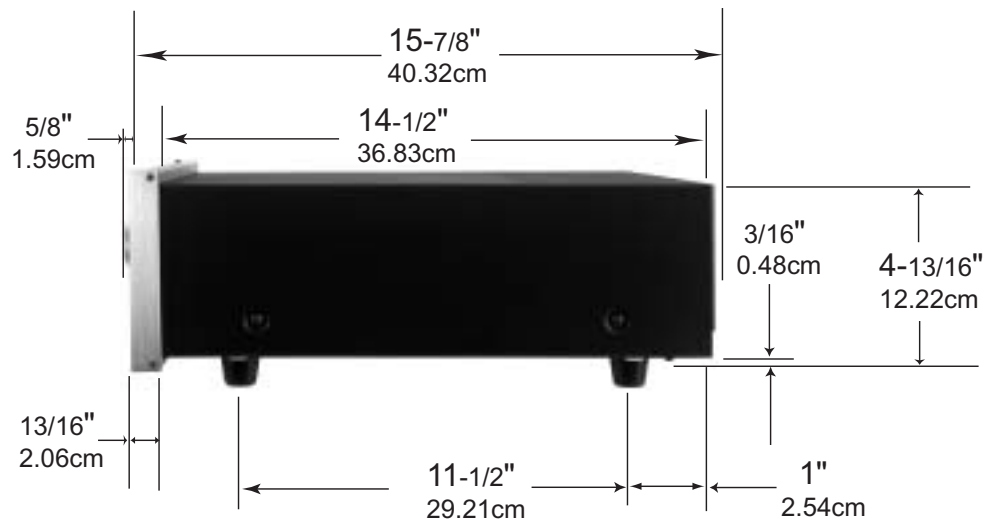

Installation

The C45 can be placed upright on a table or shelf, standing on its four feet. It also can be custom installed in a piece of furniture or cabinet of your choice. The four feet may be removed from the bottom of the C45 when it is custom installed as outlined below. The four feet together with the mounting screws should be retained for possible future use if the C45 is removed from the custom installation and used free standing. The required panel cutout, ventilation cutout and unit dimensions are shown.

Always provide adequate ventilation for your C45. Cool operation ensures the longest possible operating life for any electronic instrument. Do not install the C45 directly above a heat generating component such as a high powered amplifier. If all the components are installed in a single cabinet, a quiet running ventilation fan can be a definite asset in maintaining all the system components at the coolest possible operating temperature.

A custom cabinet installation should provide the following minimum spacing dimensions for cool

operation. Allow at least 2 inches (5.08cm) above the top, 2 inches (5.08cm) below the bottom and 1 inch (2.54cm) on each side of the Audio Control Center, so that airflow is not obstructed. Allow 17 inches (43.18cm) depth behind the front panel. Allow 1-1/8 inch (2.9cm) in front of the mounting panel for knob clearance. Be sure to cut out a ventilation hole in the mounting shelf according to the dimensions in the drawing.

C45 Front Panel Custom Cabinet Cutout

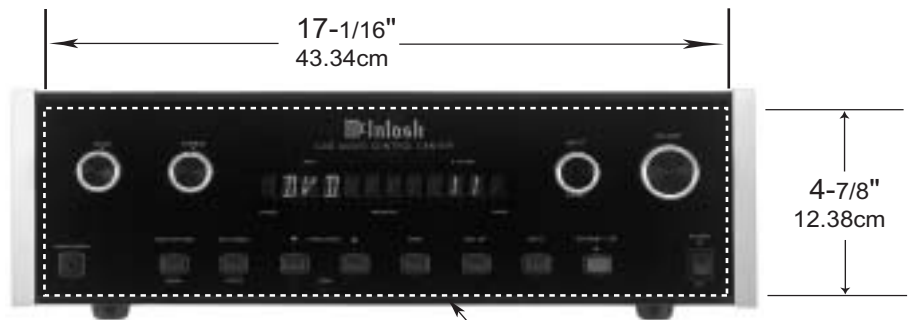

C45 Side View in Custom Cabinet

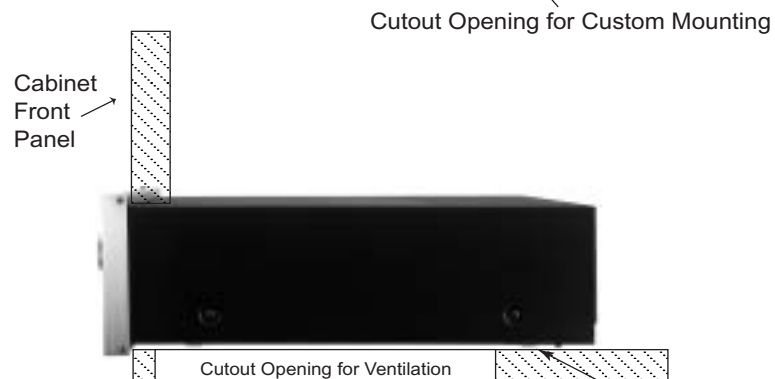

C45 Bottom View in Custom Cabinet

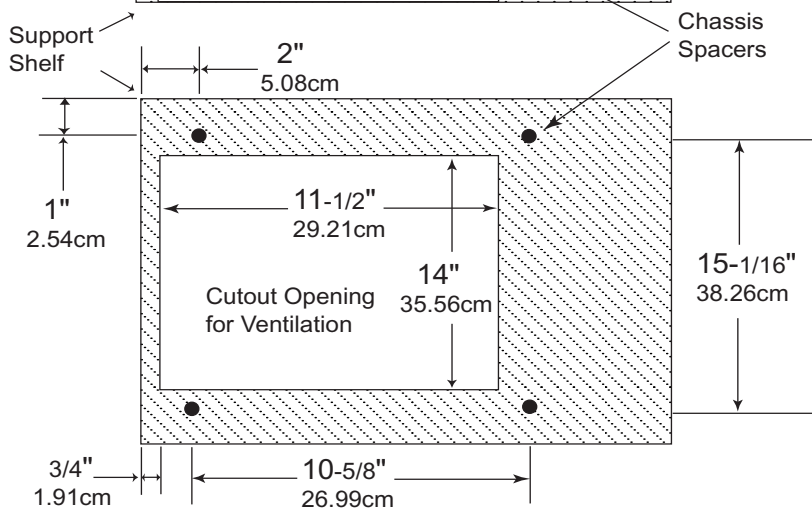

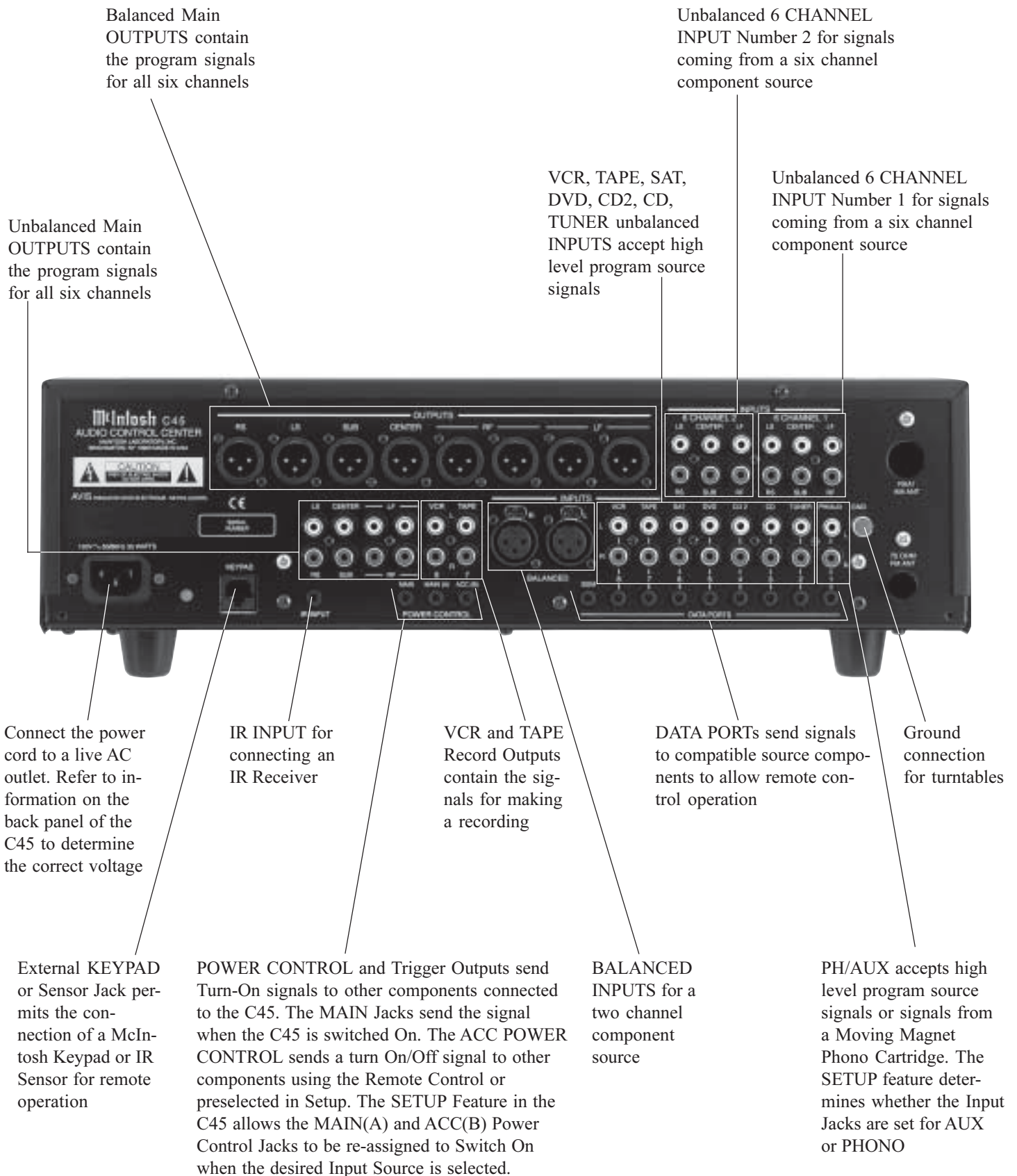

How to Connect for Power Control

The three Power Control Jacks have default settings as explained on page 8. The hookup example below utilizes the default settings. If you wish to use any one of the two assignable Power Control Outputs as a dedicated Trigger instead, connect that Component Source Unit's Power Control Input to the desired Trigger Output MAIN(A) or ACC(B). The default setting in the C45 Setup needs to be changed to match the new Power Control Connection.

1. Connect a Control Cable from the C45 POWER CONTROL MAIN(A) Jack to the Power Control In on the McIntosh CD Player.

2. Connect a Control Cable from the McIntosh CD Player Power Control Out Jack to the Power Control In Jack on the McIntosh DVD-Audio Player.
3. Optionally, connect a Control Cable from the McIntosh DVD-Audio Player Power Control Out Jack to the Power Control Jack on the McIntosh Power Control.

Note: The McIntosh Power Control provides AC Power Switching to components that do not have Power Control Connections.

4. Connect a Control Cable from the C45 POWER CONTROL MAIN Jack to the Power Control In Jack on the McIntosh Power Amplifier.

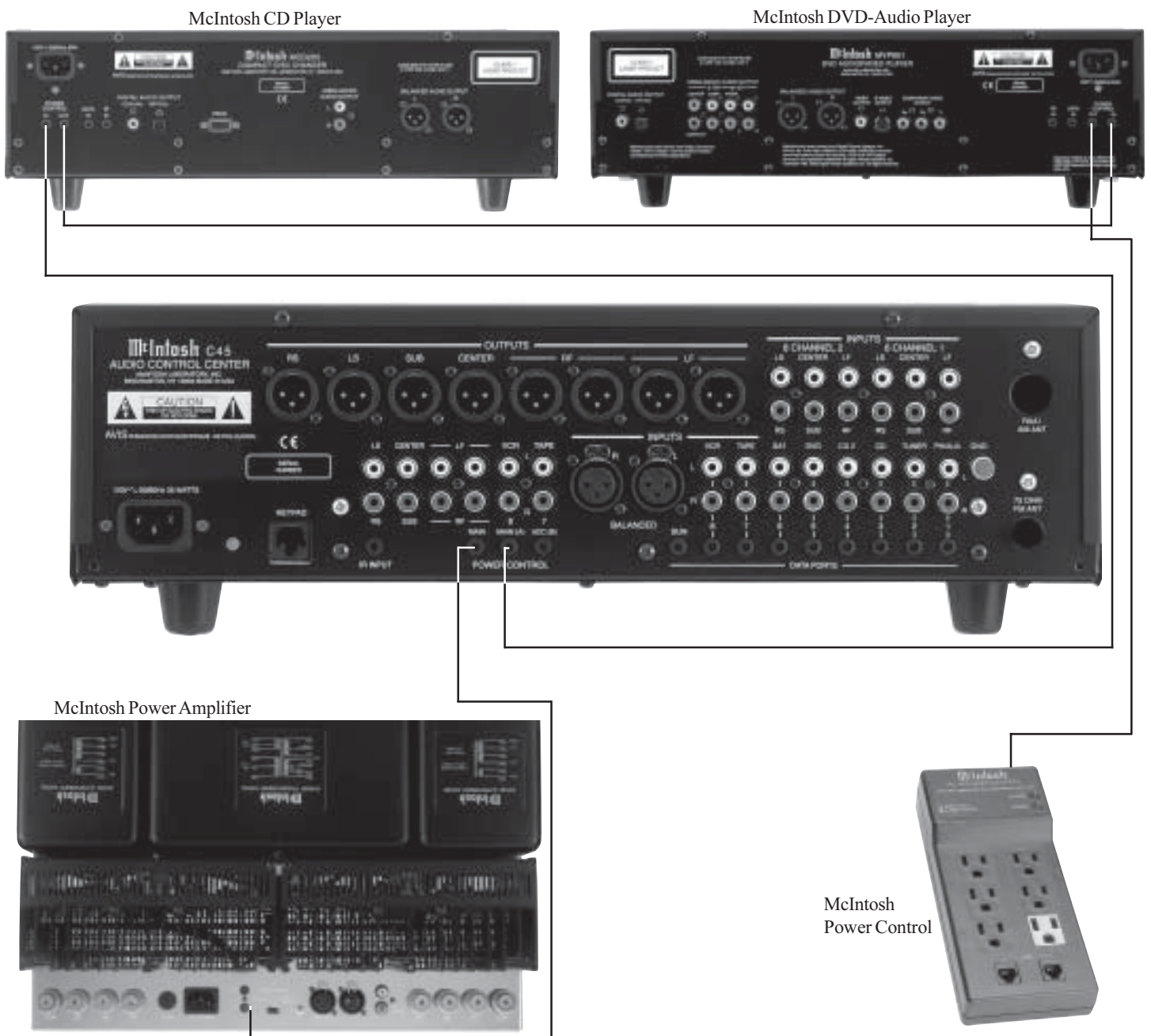

How to Connect for Data Control and Remote Operation

Data Control Connections facilitate the ability to remotely operate McIntosh Source Components using the supplied C45 Audio Control Center Remote Control. By adding a McIntosh Remote Control Translator/Repeater to the C45, non McIntosh Source Devices such as a Tape Deck can be remotely controlled using a McIntosh Remote Control and Keypad/Sensor.

1. Connect a Control Cable from the C45 DVD DATA PORT Jack to the DATA IN Jack on the McIntosh DVD-Audio Player.
2. Connect a Control Cable from the C45 TUNER DATA PORT Jack to the DATA IN Jack on the McIntosh Tuner.

3. Optionally, connect a Control Cable from the C45 TAPE DATA PORT Jack to the Number 1 DATA IN Jack on the McIntosh Remote Control Translator/Repeater. Connect the Emitter Eye plug end to the McIntosh Remote Control Translator/Repeater EMITTER Jack and attach the Emitter Eye over the IR Sensor Window on the Tape Deck.
4. Optionally, connect a cable from the KEYPAD Jack to a Keypad.

Note: A Wall Mounted IR Sensor may also be used in place of the Keypad.

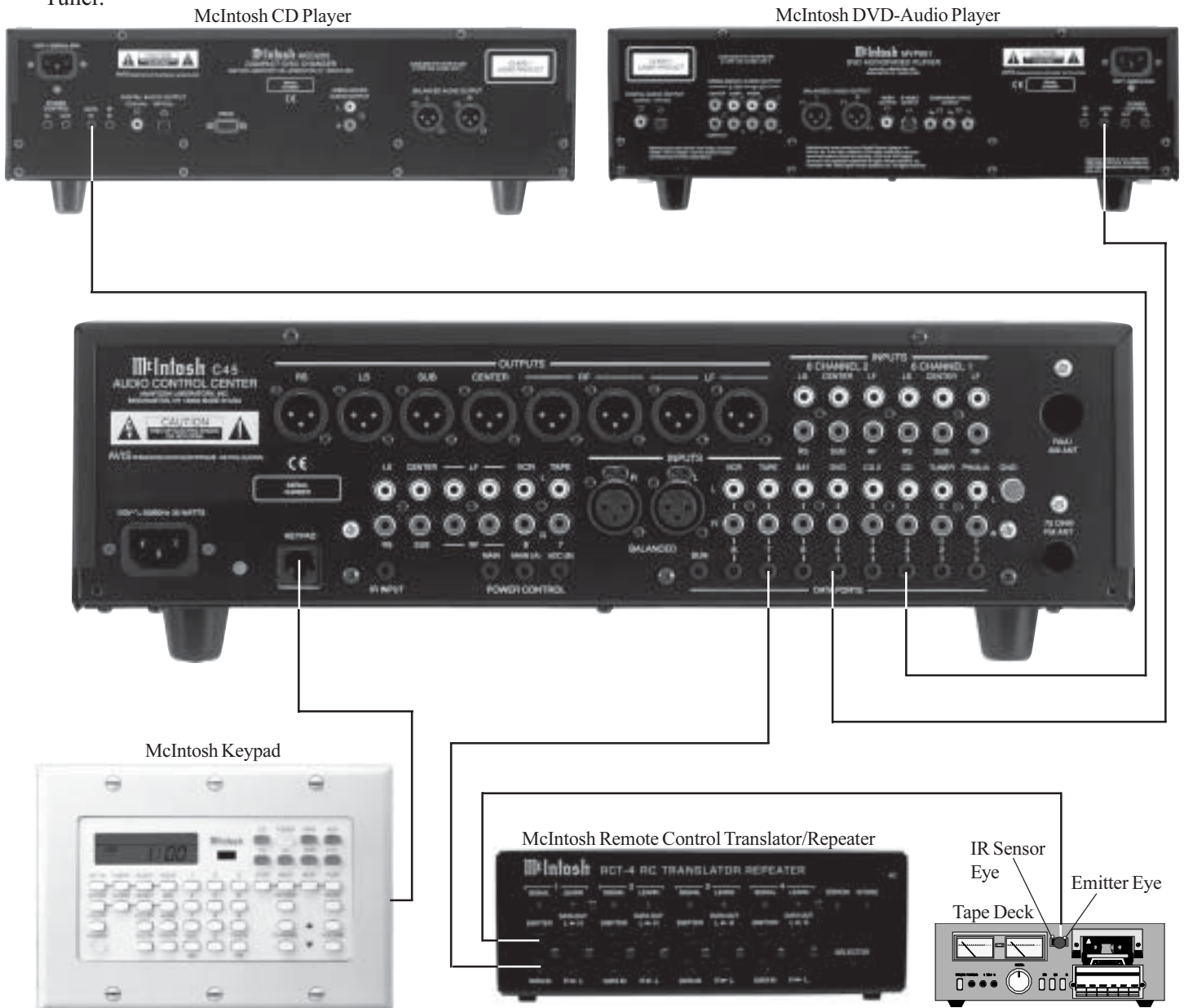

How to Connect for Two Channel Operation

The C45 Audio Control Center has assignable Inputs. Before the Balanced and Phono Inputs can be used, they must be first selected in the Setup Mode, refer pages 15, 17 and 18.

1. Connect Audio Cables from the McIntosh C45 RF and LF Balanced OUTPUTS to the McIntosh Power Amplifier Balanced INPUTS.

Note: The unbalanced RF and LF Audio OUTPUTS and unbalanced Power Amplifier Inputs may be used instead of the Balanced Connections.

2. Connect Audio Cables from the McIntosh CD Player Balanced Audio Outputs to the C45 R and L BALANCED INPUTS.

Note: The unbalanced Audio Outputs and CD2 INPUTS may be used instead of the Balanced Connections.

3. Connect Audio Cables from a McIntosh DVD-Audio Player 2CH Outputs to the C45 DVD INPUTS.
4. Connect an Audio Cable from a Turntable to the C45 PH/AUX INPUTS and the Turntable Ground Connection to the GND grounding post.
5. Connect an Audio Cable from the C45 TAPE OUTPUTS to the Record Inputs of a Tape Recorder and from the C45 TAPE INPUTS to a Tape Recorder Outputs.
6. Connect the C45 Power Cord to a live AC outlet.

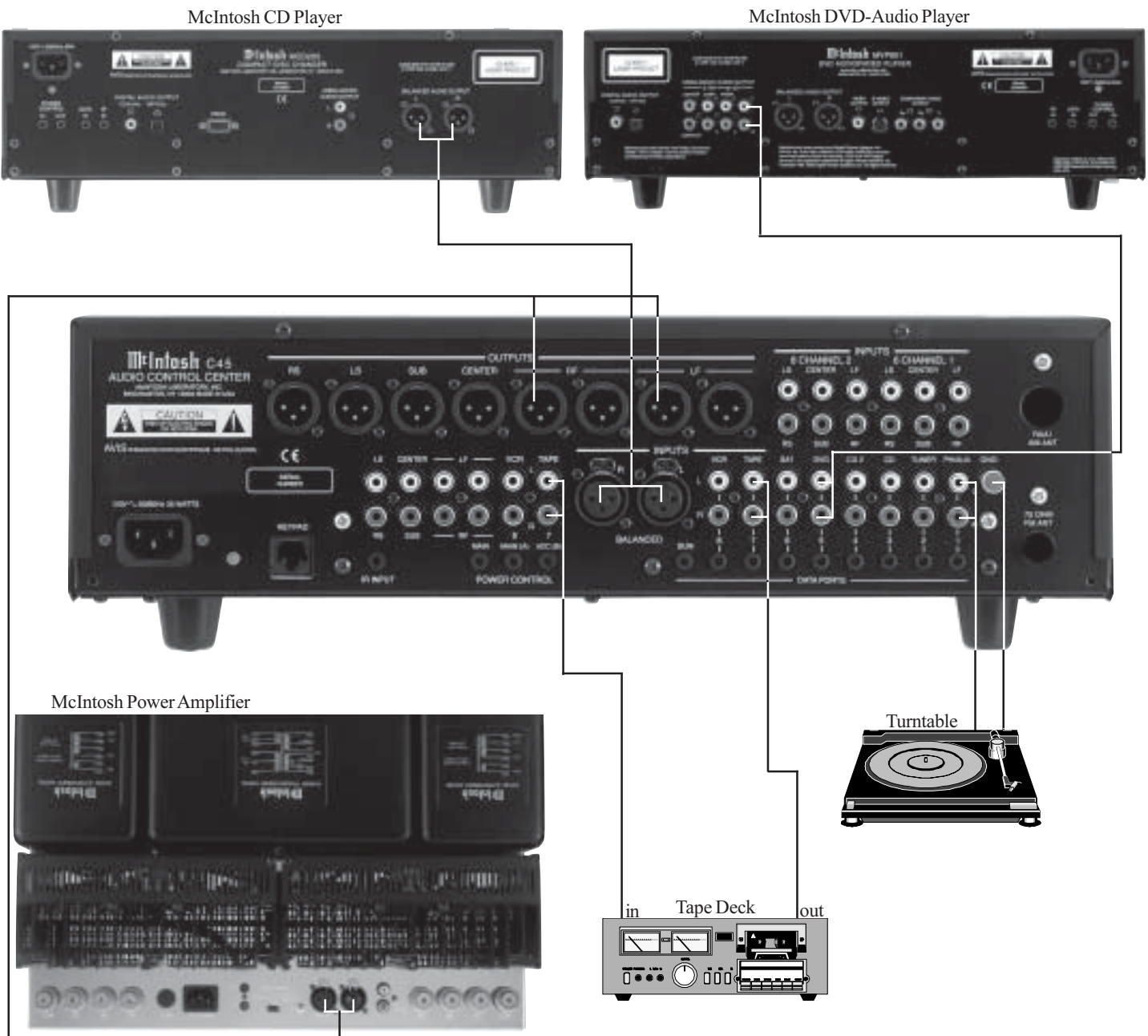

How to Connect for Six Channel Operation

The C45 Audio Control Center has assignable Inputs. Before the Balanced and Phono Inputs can be used they must be first selected in the Setup Mode. Refer pages 15, 17 and 18.

1. Connect Audio Cables from the McIntosh C45 Balanced LF (Left Front Channel) and the RF (Right Front Channel) OUTPUTS to the McIntosh Power Amplifier Number One Balanced INPUTS.

Note: The unbalanced Audio OUTPUTS and unbalanced Power Amplifier Inputs may be used instead of the Balanced Connections.

2. Connect Audio Cables from the McIntosh C45 Balanced CENTER OUTPUT to the McIntosh Single Channel Power Amplifier Balanced INPUT.

Note: The unbalanced Audio OUTPUT and unbalanced Power Amplifier Input may be used instead of the Balanced Connection.

3. Connect Audio Cables from the McIntosh C45 Balanced LS (Left Surround Channel) and the RS (Right Surround Channel) OUTPUTS to the McIntosh Power Amplifier Number Two Balanced INPUTS.

Note: The unbalanced Audio OUTPUTS and unbalanced Power Amplifier Inputs may be used instead of the Balanced Connections.

4. Connect an Audio Cable from the McIntosh C45 SUB OUTPUT to the McIntosh Powered Subwoofer Left Input.

5. Connect Audio Cables from the McIntosh CD Player Balanced Audio Outputs to the C45 R and L BALANCED INPUTS.

Note: The unbalanced Audio Outputs and CD2 INPUTS may be used instead of the Balanced Connections.

6. Connect Audio Cables from a McIntosh DVD-Audio Player 5.1CH Outputs to the C45 6 CHANNEL 1 INPUTS.

7. Connect Audio Cables from a McIntosh DVD-Audio Player 2CH Outputs to the C45 DVD INPUTS.

8. Connect an Audio Cable from a Turntable to the C45 PH/AUX INPUTS and the Turntable Ground Connection to the GND grounding post.

9. Connect an Audio Cable from the C45 TAPE OUTPUTS to the Record Inputs of a Tape Recorder and from the C45 TAPE INPUTS to the Tape Recorder Outputs.

10. Connect the C45 Power Cord to a live AC outlet.

McIntosh Two Channel Power Amplifier Number One

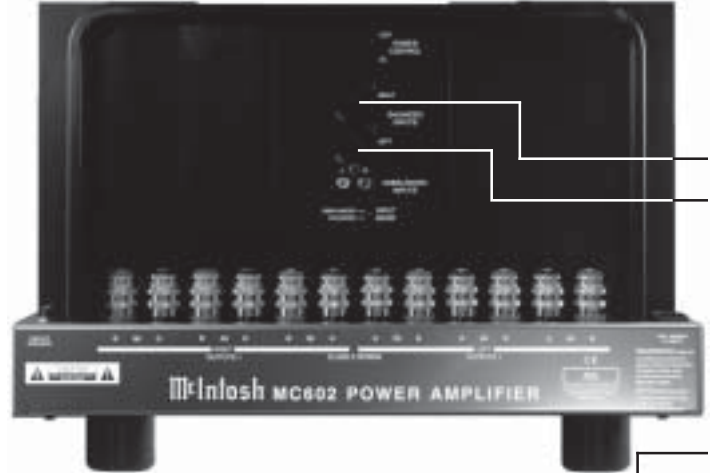

McIntosh Single Channel Power Amplifier

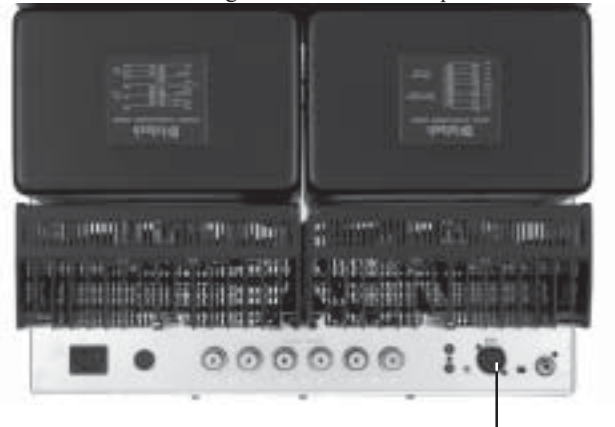

McIntosh Two Channel Power Amplifier Number Two

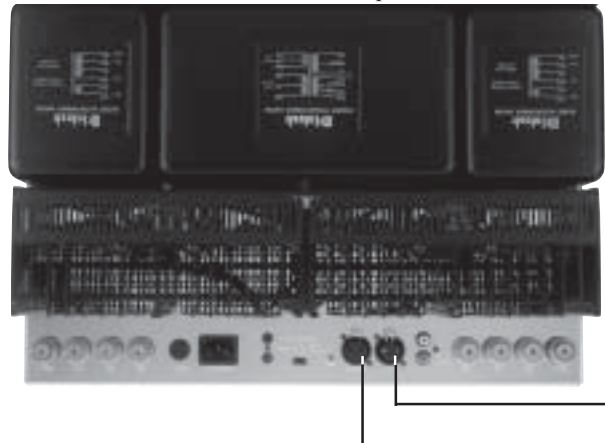

How to Connect for Six Channel Operation

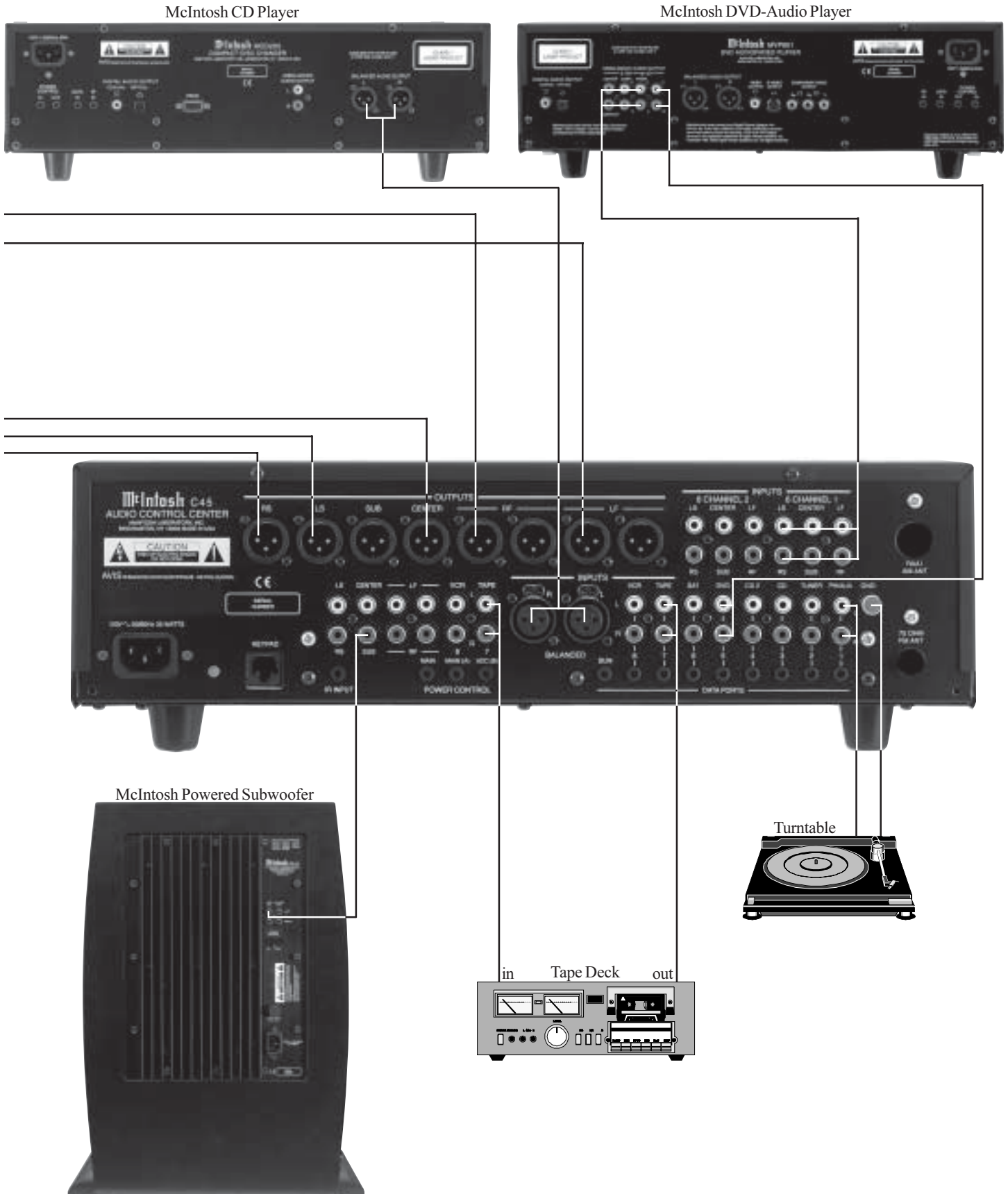

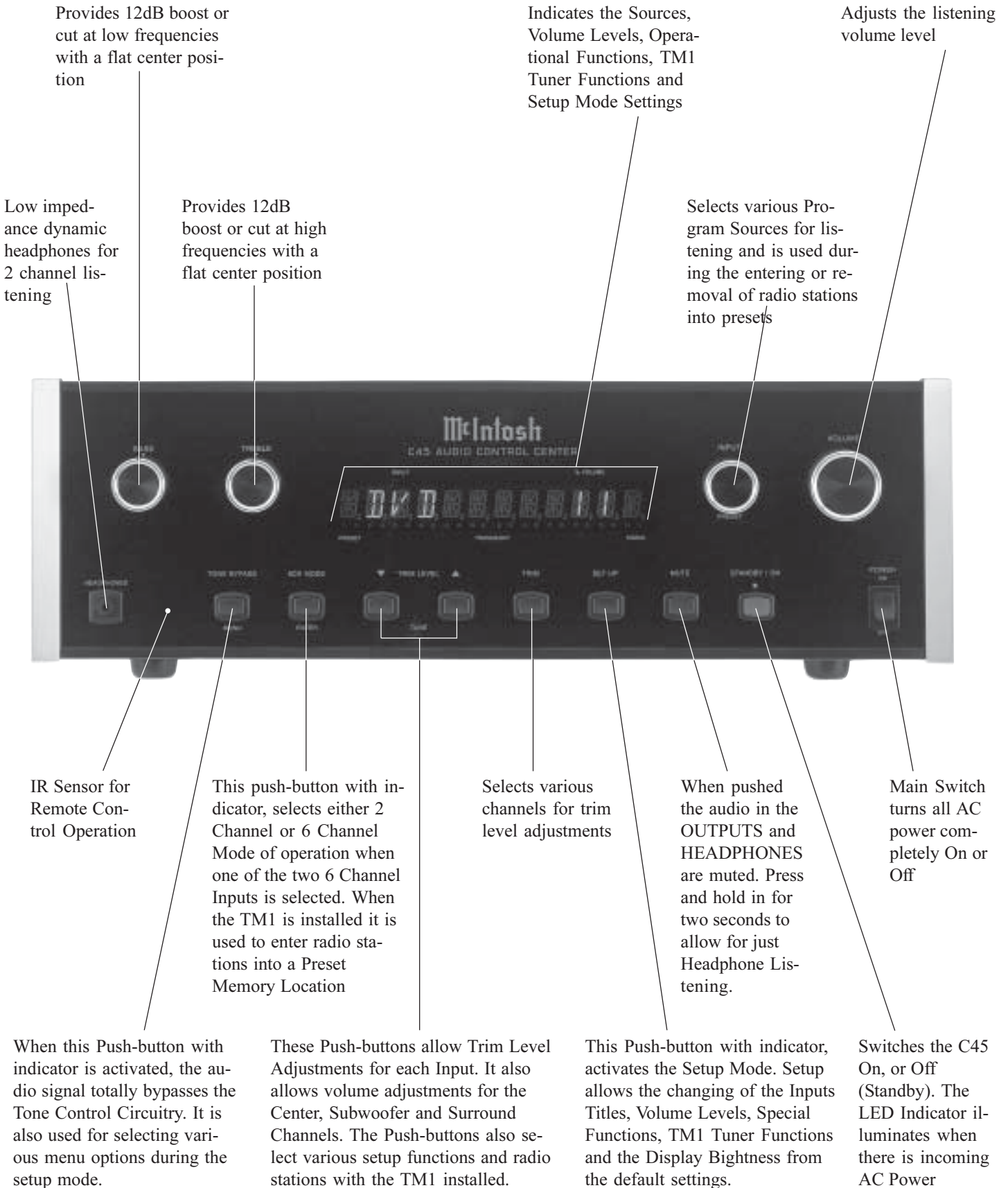

How to Operate the Setup Mode

Your McIntosh C45 has been factory configured for default operating settings that will allow immediate enjoyment of superb audio without the need for further adjustments. If you wish to make changes to the factory default settings, a Setup Feature is provided to customize the operating settings using the Front Panel Alphanumeric Display.

1. Press the POWER Switch to ON, the Red LED above the STANDBY/ON Push-button lights to indicate the C45 is in Standby mode. To switch On the C45 press the STANDBY/ON Push-button. Refer to figure 3.
2. Press the C45 Front Panel SETUP Push-button. The LED above the SETUP Push-button will illuminate and the Front Panel Display will indicate DISPLAY 10. Refer to figure 1.



Figure 1

Note: The Front Panel Display will indicate DISPLAY 10 the first time, after that it will display whatever Setup Mode was last accessed.

3. Press TONE BYPASS (Menu) Push-button and notice that with each press of the push-button, the Setup Mode advances through ten different possible adjustment selections and one informational display.

Note: If the optional TM1 AM/FM Tuner Module is installed into the C45 there will be 2 additional adjustments relating to the TM1.



Figure 2

4. To exit from a specific Setup Mode, press the SETUP Push-button a second time. The LED above the SETUP Push-button will extinguish and the Front Panel Display will revert back to its normal display. Refer to figure 2.

Default Settings

The following listings indicate the default settings without the optional TM1 AM/FM Tuner Module installed and the page number for instructions on how to change a setting:

Setup Function Name	Setting	Page Number
Display (Brightness)	10	16
Version (C45 Firmware)	-- . --	16
Input 2	*TUN	17
Level (Input Trim)	0.0	17
6 Channel 1 (Input)	Off	18
6 Channel 2 (Input)	Off	18
Balanced (Input)	Off	18
2Ch Sub	Off	19
Trig Tun	--	19
AutoTone	Off	19
Remote (Control Type)	Norm	20

The following listings indicate the default settings with the optional TM1 AM/FM Tuner Module installed and the page number for instructions on how to change a setting:

Setup Function Name	Setting	Page Number
Display (Brightness)	10	16
Version (C45 Firmware)	-- . --	16
Country Code		16
Tune - >	Tune	16
Input 0	*TUN	17
Level (Input Trim)	0.0	17
6 Channel 1 (Input)	Off	18
6 Channel 2 (Input)	Off	18
Balanced (Input)	Off	18
2Ch Sub	Off	19
Trig Tun	--	19
AutoTone	Off	19
Remote (Control Type)	Norm	20



Figure 3

Display Brightness

The Front Panel Alphanumeric DISPLAY Brightness may be varied from a setting of 1 (Dim) to 15 (Bright). Follow the steps below for reducing the Display Brightness. Refer to figure 4.



Figure 4

1. Press the SETUP Push-button to access the Setup Mode.
2. Press the TONE BYPASS (Menu) Push-button until the word DISPLAY 10 appears.
3. Press the TRIM LEVEL Down ▼ Push-button until the Front Panel Alphanumeric Display indicates “Display 5”.
4. Press the SETUP Push-button to exit the Setup Mode.

Firmware Version

The C45 functionality is controlled by internal software that is known as Firmware. The Version of the Firmware in the C45 can be identified at any time by utilizing the Setup Mode.

1. Press the SETUP Push-button to access the Setup Mode.
2. Press the TONE BYPASS (Menu) Push-button until VERSION 1.0 or higher appears. Refer to figure 5.



Figure 5

3. The number after the word VERSION is the Firmware number.

Note: If the optional TM1 AM/FM Tuner Module is installed into the C45 there is an extra character that appears to the right of the version number. This character indicates for which country the TM1 is set. Refer to figure 6.



Figure 6

4. Press the SETUP Push-button to exit the Setup Mode.

Country Code

The C45 allows for selection of the country for proper AM and FM reception, when the optional TM1 AM/FM Tuner Module is installed. Refer to figure 3 on page 15.

Note: When the C45 is in the Setup Mode the COUNTRY CODE setting will only appear if the optional TM1 Tuner Module is installed.

1. Press the SETUP Push-button to access the Setup Mode.
2. Press the MENU Push-button until the Front Panel Alphanumeric Display indicates COUNTRY CODE. Refer to figure 7.



Figure 7

3. Press the TRIM LEVEL UP ▲ or DOWN ▼ Push-button to change the Country Group, the choices are USA, Japan and Europe. Refer to figure 8.



Figure 8

4. To verify the correct setting, press the TONE BYPASS (Menu) Push-button until the version number appears. The character to the right of the version number indicates the Country setting. Refer to figure 6.

<u>Alphanumeric Display</u>	<u>Country Group</u>
VERSION _._ U	USA
VERSION _._ J	JAPAN
VERSION _._ E	EUROPE

5. Press the SETUP Push-button to exit the Setup Mode.

Tune

The C45 allows choosing from three different tuning methods for AM and FM station selection using the Front Panel TUNE UP ▲ or DOWN ▼ Push-buttons, when the optional TM1 AM/FM Tuner Module is installed. Refer to figure 3 on page 15.

Note: When the C45 is in the Setup Mode the TUNE setting will only appear if the optional TM1 Tuner Module is installed.

1. Press the SETUP Push-button to access the Setup Mode.
2. Press the MENU Push-button until the Front Panel Alphanumeric Display indicates TUNE -> TUNE. Refer to figure 9.



Figure 9

3. Press the TRIM LEVEL UP ▲ or DOWN ▼ Push-button to change the Tuning method, the choices are TUNE, PRESET and SEEK. Refer to figures 10 and 11.



Figure 10



Figure 11

Tuning Method	Description
TUNE -	Allows for Manual Tuning Up or Down the radio dial.
PRESETS -	Allows selection of a radio station preset from a previously stored station in memory.
SEEK -	Automatically scan the dial and will stop on the next available station.

4. Press the SETUP Push-button to exit the Setup Mode.

Re-Title Inputs

The C45 has nine Audio Inputs, which include the optional TM1 AM/FM Tuner Module. These inputs already have assigned titles that will allow for immediate hookup, operation and enjoyment. In addition, there are two 6 channel inputs and a balanced input that are assignable as replacement for each one of the inputs.

If these starting assignments do not match up with components in your system, they may be reassigned from the default settings. The following example will illustrate how to rename the AUX Input to PHONO. When the Input Selector is rotated to select what was originally the AUX Input, PHONO will now appear on the Front Panel Alphanumeric Display. Refer to figure 3 on page 15.

- Notes:*
1. Unused Inputs may be switched Off so they will not appear when rotating through the input source choices using the Input Selector and also will not be available when using the Remote Control or Keypad. Refer to figure 12.
 2. The New Input Titles that are available for all the Inputs include TAPE 2, LV, TV, and VCR2. The AUX Input (INPUT 1) Titles also includes PHONO.



Figure 12

1. Press the SETUP Push-button to access the Setup Mode.
2. Press the TONE BYPASS (Menu) Push-button until "INPUT _ _" appears on the Front Panel Alphanumeric Display.

3. Press the TRIM LEVEL UP▲ or Down▼ Push-button until the Front Panel Alphanumeric Display indicates "INPUT 1 *AUX". Refer to figure 13.



Figure 13

4. Rotate the INPUT Control clockwise until the display indicates "INPUT 1 PH". Refer to figure 14.



Figure 14

5. Press the SETUP Push-button to exit the Setup Mode.

Level Adjustment

Various Source Components can have slightly different volume levels. This could result in the constant need to readjust the C45 Volume Control when switching between different Input Sources. The Level Input Trim Feature on the C45 allows the adjustment of levels for each of the Source Inputs, so that they have the same relative volume. The Tuner and CD Inputs are used in the following example. Refer to figure 3 on page 15.

Notes: The possible range of adjustment in volume level is $\pm 6\text{dB}$. The Tape/Record Output Levels are unaffected by any changes in the Level Trim Settings. Any LEVEL Trim adjustments made are retained in permanent memory and can be changed only by performing a new Level Trim Procedure. The Tuner Input Volume Level can serve as a reference or choose another Input Source that is frequently listened to as the reference. The reference Input Source should be set to a Level of 00.

1. Rotate the INPUT Control to select the Tuner Input and adjust the VOLUME Control to the desired listening level.
2. Press the SETUP Push-button to access the Setup Mode.
3. The Front Panel Alphanumeric Display will change and the Red LED above the SETUP Push-button will be illuminated.
4. Press the TONE BYPASS (Menu) Push-button until "LEVEL 0.0 ___" appears on the Front Panel Alphanumeric Display.
5. Rotate the INPUT Counter-clockwise until the display indicates "LEVEL 0.0 TUN". Refer to figure 15 on the next page.



Figure 15

6. Press the TRIM LEVEL UP▲ or Down▼ Push-button until the Front Panel Alphanumeric Display indicates “LEVEL 0.0 TUN”.
7. Rotate the INPUT Clockwise until the display indicates “LEVEL 0.0 CD2”. Refer to figure 16.



Figure 16

8. Press the TRIM LEVEL UP▲ or Down▼ Push-button until Volume Level of the CD Input is the same as the Tuner Volume Level. Figure 17 indicates a 2.5dB decrease in the CD Level. Refer to figure 17.



Figure 17

9. Rotate the INPUT Control until the next desired Input Source Name is displayed.
10. Repeat steps 5, 6, 7 and 8 until all the Inputs with sources connected to the C45 have the same relative volume levels when switching between them.
11. Press the SETUP Push-button to exit the Setup Mode.

Note: The Level Input Trim can also be set via the Remote Control. A chart has been provided below to record the changes to the various inputs from the default settings.

Input Source Settings				
Number	Default Title	New Title	Trim	Trigger
1	AUX			
2	TUNER			
3	CD			
4	CD2			
5	DVD			
6	SAT			
7	TAPE			
8	VCR			

6 Channel 1 and 2 Inputs

The C45 has two six channel analog Audio Inputs that are assignable as replacement to one of the eight two channel inputs. The following example will illustrate how to assign Input 6 CHANNEL 1 to the DVD Input. Refer to figure 3 on page 15.

Note: When a 6 Channel Input is assigned to a given Input, the Audio Signal present at that given 2 Channel Input Jacks is available at the Tape and VCR Output Jacks for recording.

1. Press the SETUP Push-button to access the Setup Mode.
2. Press the TONE BYPASS (Menu) Push-button until “6 CHAN 1 OFF” appears on the Front Panel Alphanumeric Display. Refer to figure 18.



Figure 18

3. Rotate the INPUT Control clockwise until the display indicates “6 CHAN 1 DVD”. Refer to figure 19.



Figure 19

Note: The other six channel (Input 6 CHAN 2) may be assigned in a similar manner.

4. Press the SETUP Push-button to exit the Setup Mode.

Balanced Input

The C45 has one Balanced Audio Input that is assignable to one of the eight two channel inputs. The following example will illustrate how to assign the Balanced Input to the CD2 Input. Refer to figure 3 on page 15.

Note: If the Balanced Input is assigned to an Input that has already been assigned to a 6 Channel Input, the Audio Signal present at the Balanced Input Jacks will replace the Audio Signal present at the Left Front and Right Front Unbalanced Jacks.

1. Press the SETUP Push-button to access the Setup Mode.
2. Press the TONE BYPASS (Menu) Push-button until “BALANCED OFF” appears on the Front Panel Alphanumeric Display. Refer to figure 20.



Figure 20

3. Rotate the INPUT Control clockwise until the display indicates "BALANCED CD2". Refer to figure 21.
4. Press the SETUP Push-button to exit the Setup Mode.



Figure 21

2 Channel Sub

The C45 has both Balanced and Unbalanced SUBwoofer Outputs. If either one of the 6 Channel Inputs are selected, the C45 Amplifies the signal at the SUBwoofer Input and makes it available at the SUBwoofer Output. When a 2 Channel Input is selected the C45 is also capable of providing signal at the SUBwoofer Outputs by performing the following steps: Refer to figure 3 on page 15.

Note: If the C45 is to be used as a two channel only preamp, one of the SUBwoofer Outputs may be connected to an additional power amplifier and Loudspeaker to provide a "center fill channel". The SUBwoofer Outputs are Full Range Audio Frequency Outputs and the signal present is a sum of both Left and Right Channels.

1. Press the SETUP Push-button to access the Setup Mode.
2. Press the TONE BYPASS (Menu) Push-button until "2CH SUB OFF" appears on the Front Panel Alphanumeric Display. Refer to figure 22.



Figure 22

3. Press the TRIM LEVEL UP ▲ or Down ▼ Push-button until the display indicates "2CH SUB ON". Refer to figure 23.



Figure 23

4. Press the SETUP Push-button to exit the Setup Mode.

Power Control Triggers

Two of the three C45 Power Control Outputs are reassignable from their default settings, allowing for various functions such as activating only when a given Input is selected.

In the following example the Power Control MAIN(A) Jack will be reassigned to function as TRIGGER A for the DVD Input.

1. Press the SETUP Push-button to access the Setup Mode.
2. Press the TONE BYPASS (Menu) Push-button until "TRIG TUN > - -" appears on the Front Panel Alphanumeric Display. Refer to figure 24.



Figure 24

3. Rotate the INPUT Control clockwise until the display indicates "TRIG DVD > - -". Refer to figure 25.



Figure 25

4. Press the TRIM LEVEL UP ▲ or Down ▼ Push-button until the display indicates "TRIG DVD > A". Refer to figure 26.



Figure 26

5. Press the SETUP Push-button to exit the Setup Mode.

Auto Tone

The C45 Audio Control Center allows for the audio signal to totally bypass the Tone Control Circuitry by pressing the Front Panel TONE BYPASS Push-button. It also has the ability to remember for each input if the TONE BYPASS has been activated, by setting the AUTOTONE feature to the On position. To activate this feature perform the following steps:

1. Press the SETUP Push-button to access the Setup Mode.
2. Press the TONE BYPASS (Menu) Push-button until "AUTOTONE OFF" appears on the Front Panel Alphanumeric Display. Refer to figure 27.



Figure 27

3. Press the TRIM LEVEL UP▲ or Down▼ Push-button until the display indicates “AUTOTONE ON”. Refer to figure 28.



Figure 28

4. Press the SETUP Push-button to exit the Setup Mode.

Remote Control Selection

The C45 will respond to two different sets of the Remote Control Codes. The Remote Control included with the C45 utilizes the NORMal McIntosh Control Codes. The Second Set of Control Codes the C45 will respond to is referred to as the ALTErnate Codes. The ALTErnate Codes are for when the C45 is used together with an other McIntosh Audio or Audio/Video Control Center or Preamplifier in the same system. This will prevent the Remote Control from affecting the operation of both units at the same time.

Note: If the ALT Remote Control Code is selected, the C45 will not respond using the supplied McIntosh Remote Control. See your McIntosh Dealer for additional information.

1. Press the SETUP Push-button to access the Setup Mode.
2. Press the TONE BYPASS (Menu) Push-button until “REMOTE NORM” appears on the Front Panel Alpha-numeric Display. Refer to figure 29.



Figure 29

3. Press the TRIM LEVEL UP▲ or Down▼ Push-button until the display indicates “REMOTE ALT”. Refer to figure 30.



Figure 30

4. Press the SETUP Push-button to exit the Setup Mode.

How to Operate the C45

The McIntosh C45 Audio Control Center has been factory configured for operating settings that allow immediate enjoyment of superb high fidelity audio without the need for further adjustments. If you wish to make changes to the factory default settings, refer to the SETUP Section of this Owner's Manual starting on page 15.

Power On and Off

Press the POWER switch to ON, the Red LED above the STANDBY/ON Push-button lights to indicate the C45 is in Standby Mode. To Switch On the C45 press the STANDBY/ON Push-button. Refer to figures 31 and 32.

Notes: For normal operation, switch the C45 On and Off with the Standby/On Push-button. You may also turn On the C45 by simply pressing the Power Push-button on the Remote Control. If the C45 is not going to be used for an extended period of time, turn Off all AC Power with the Power Switch.

Input Source Selection

Select the desired Source with the Front Panel INPUT Control or the Source Push-button on the Remote Control.



Figure 31

Volume Control

Adjust the Front Panel VOLUME Control or the Up▲ / Down▼ Push-buttons on the Remote Control for the desired listening level.

Mute

Press the MUTE Push-button, on the C45 Front Panel or on the Remote Control, to Mute the Audio at the OUTPUTS Connectors and HEADPHONES Output Jack. The Front Panel Alphanumeric Display will indicate the Input Source Name followed by the word MUTE in place of the actual volume setting. Refer to figure 33.



Figure 33

Pressing the Mute Push-button a second time or adjusting the volume control (either the Front Panel or Remote Control) will un-mute the C45.

If the Front Panel MUTE Push-button is pressed for at least 3 seconds, the C45 will mute the OUTPUTS connectors, yet listening with headphones will continue until the Mute Push-button is pressed again. Refer to figure 34.



Figure 34

Tone Bypass

Press the TONE BYPASS Push-button to totally bypass the Tone Control Circuitry, providing a flat frequency response. If the AUTOTONE circuit is set to the On position in Setup Mode, the C45 will remember for each input whether the Tone Bypass is active.



Figure 32

Bass and Treble Controls

Adjust the BASS and TREBLE controls to suit your listening preferences. The Bass or Treble intensity can be increased with clockwise rotation and decreased with counter-clockwise rotation. All tone control circuit elements are removed from the signal path when the controls are in the center or flat position.

Note: The Bass and Treble controls affect the Front Left and Right Channels only.

6 Channel Mode

When a 6 Channel Input has been assigned to one of the eight inputs and that Input is selected, the C45 will automatically switch to the 6 Channel Mode and the red Led above the 6 CH MODE Push-button will illuminate. If the 6CH MODE Push-button is pressed at that time the C45 will revert back to the 2 Channel Mode and the Audio Signal present at that Input's Left and Right 2 Channel jacks will be heard instead.

Note: The C45 will retain the choice of 2 Channel Mode until either the 6CH MODE Push-button is pressed when the C45 is on that six channel Input or the C45 is switched Off and then On. If the optional TMI Tuner Module is installed into the C45, the 6CH MODE (ENTER) Push-button is also used to enter AM/FM Radio Station(s) into Preset Memory. Refer to page 31 for additional information.

Trim and Trim Level

When the C45 is in the 2 Channel Mode and the 2CH SUB Mode is set to ON in the Setup Mode, the TRIM and TRIM LEVEL Push-buttons provide the means for adjusting the Subwoofer Volume Level separately from the main left and right channels. Refer to page 19 for changing the 2CH SUB Mode. If an Input is assigned as a 6 Channel Input, there are Volume Trim Adjustments for the Center, Subwoofer and Surround Channels.

The Trim Adjustments can be accomplished from either the Front Panel Controls or with the supplied Remote Control. There is a ± 12 dB range of volume adjustment for each of the Trim Selections.

The C45 has separate Subwoofer Trim Levels for both the 2CH and 6CH Modes of operation. It will also reset the Center, Subwoofer and Surround Trim Levels to 0dB when the C45 is turned Off. The Front Panel Alphanumeric Display indicates the Trim Mode Selected and Trim Levels. Refer to figures 40 and 41.

Note: If the optional TMI Tuner Module is installed into the C45, AM/FM Radio Stations may be selected by using the TRIM LEVEL (TUNE) Up▲ or Down▼ Push-buttons. Refer to page 30 for additional information.

1. Press and release the TRIM Push-button until "SUB 0.0" appears on the Front Panel Display.

Note: Low Frequency Information must be present in the Program Source Material in order to hear any changes in the Subwoofer Levels.

2. Press the LEVEL Up▲ Push-button until "SUB 4.5" appears on the Front Panel Display. This is an example of increasing the Subwoofer Channel Level by 4.5dB. Refer to figure 35.



Figure 35

3. Select an Input that is assigned with a 6 Channel Input Source, making sure that the LED above the 6CH MODE Push-button is illuminated.
4. Press and release the TRIM Push-button until "CENTER 0.0" appears on the Front Panel Display.
5. Press the LEVEL Up▲ Push-button until "CENTER 3.5" appears on the Front Panel Display. This is an example of increasing the Center Channel Level by 3.5dB. Refer to figure 36.



Figure 36

6. Press and release the TRIM Push-button until "SURROUND 0.0" appears on the Front Panel Display.
7. Press the LEVEL Down▼ Push-button until "SURROUND -8.5" appears on the Front Panel Display. This is an example of decreasing the Center Channel Level by 8.5dB. Refer to figure 37.

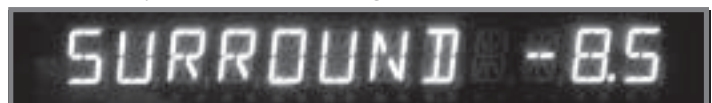

Figure 37

Note: Approximately four seconds after no additional Trim adjustments are made, the C45 Front Panel Display will revert back to indicating the selected input source and volume setting. To exit quickly from the TRIM Mode, press and release the TRIM Push-button until the Name of the Input selected reappears on the display.

Setup

Pressing the SETUP Push-button activates the Setup Mode of the C45 and allows customizing various operating functions. Refer to the SETUP Section of this Owner's Manual starting on page 15. Refer to figure 40.

Reset of Microprocessors

In the event that the controls of the C45 stop functioning, push the POWER switch OFF and wait about two minutes. Then push the POWER switch ON followed by pushing the STANDBY/ON Push-button. This will reset the C45 microprocessors and the Audio Control Center will be returned to normal operation.

Note: The above condition is usually caused by either interruptions in AC power and/or major changes that may occur in AC power line voltage.

Default Settings

To restore the C45 to Factory Default Settings perform the following. Press and hold in the 6CH MODE Push-button together with the MUTE Push-button. Approximately 5 seconds after holding in the Front Panel Push-buttons, the Front Panel Alphanumeric Display will indicate "MASTER RESET". Refer to figure 38.



Figure 38

Release both Push-buttons and the Front Panel Alphanumeric Display will now indicate "-- CLEARED --" and the C45 will switch Off. Refer to figure 39.



Figure 39

Press the STANDBY/ON Push-button on the C45 and proceed to the Setup on page 15 to re-enter and custom settings that have been previously made.



Figure 41



Figure 40

Press to Power the C45 ON or OFF

Turns AC Power ON or OFF to certain McIntosh Components when connected via the Data Port

Selects one of the available Audio Sources

Press the push-button to illuminate the keys

Selects a Disc Player or Tape Recorder Functions and also performs various functions on a variety of McIntosh Components. The Next and Back Push-buttons will step through Radio Station Presets with the optional TM1 AM/FM Tuner Module.

Selects the REWIND Mode on Disc Players and Tunes Down the AM/FM Dial

Use to select tuner presets, disc tracks or any numbered operation

Selects AM Tuner Operating Functions and Disc Selection on certain McIntosh Disc Players

Selects FM Tuner Operating Functions and Track Selection on certain McIntosh CD Players

Mutes the audio



Selects On Screen Functions for McIntosh certain Disc Players

Press to REVIEW Tuner Station Presets and select certain functions on McIntosh Disc Players

Selects the Fast Forward Mode on Disc Players and Tunes Up the AM/FM Dial

Press MODE to switch between 2 or 6 Channel Modes

Press TRIM and then the LEVEL Push-buttons to adjust various Sound Levels

Adjusts the volume level up or down

Note: The HOME Push-button is for use with other McIntosh Products.

How to Operate by Remote Control

The supplied Remote Control is capable of directly controlling the functions of contemporary McIntosh Source Components connected to the C45. Earlier McIntosh source components and other brand source components can be controlled by the C45 with the addition of a McIntosh Remote Control Translator (RCT).

Note: Your McIntosh Dealer can assist you with the installation and operation of the Remote Control Translator (RCT).

Mute

Press the MUTE Push-button to mute audio at the Audio Control Center Outputs, except the TAPE and VCR OUTPUTS. Press MUTE a second time to unmute audio.

Mode

Press the MODE Push-button to select between 2 Channel and 6 Channel operation.

Trim and Level

Press the TRIM Push-button to active the TRIM Function. Press the TRIM LEVEL Up▲ and Down▼ Push-buttons to adjust the Sound Level or various channels. For additional information refer to page 22.

Input Source Selection

Press one of the Input Push-buttons to select either a default or reassigned program source.

Disc/Tape Functions

Use these push-buttons to operate a Disc Player or Tape Recorder.

Numbered Push-buttons

Press Push-buttons 0 through 9 to access tuner station presets or Disc chapters/tracks/discs.

Disc and Track

Use the DISC and TRACK Push-buttons when a Disc Player is being used.

Note: Certain Disc Players will require a Numbered Push-button be pressed immediately after the Disc or Track Push-button is depressed.

Tuner Push-buttons

Press the AM or FM Push-button to select the desired broadcast band. Press and release the Channel Up▲ or Down▼ Push-button to move from station to station. Press and hold a Channel Up▲ or Down▼ Push-button to move continuously from station to station. Press REVIEW to start

the automatic brief audition of each of the presets stored in the tuner memory. Press REVIEW a second time to stop on a station preset and exit the Review process. Press the NEXT or BACK Push-buttons to step through the Preset Radio Stations when the optional TM1 AM/FM Tuner Module is installed into the C45.

Volume

Press the Up▲ or Down▼ VOLUME Push-button to raise or lower the listening volume level.

Note: The TAPE and VCR OUPUTS are not affected by volume changes.

Acc On/Acc Off

Press ACC ON to turn the power ON to certain McIntosh Disc Players. Press ACC OFF to turn the power OFF to certain McIntosh Disc Players. The ACC ON/OFF Push-buttons also control the signal at the ACCessory(B) Power Control Jack, unless it is reassigned to a specific Input(s) from the default setting. For additional information refer to page 19 "Power Control Triggers" in this manual.

Note: When the C45 is switched Off (Standby Mode) the ACCessory(B) Power Control Signal will be reset to the default turn-on setting of Off.

E

Press E || to perform various functions on a variety of McIntosh Components. It will also pause the playing of a Disc or Tape playback.

Lighting

Press and release the LIGHTING Push-button to momentarily illuminate the upper half of the Remote Control Push-buttons.

Note: While the LIGHTING Push-button is being depressed the Remote Control will be unable to send a remote command. When the LIGHTING Push-button is released the push-buttons will continue to stay illuminated for approximately three seconds thus allowing you to send the desired command.

Specifications

Frequency Response

+0, -0.5dB from 20Hz to 20,000Hz

Total Harmonic Distortion

0.002% maximum from 20Hz to 20,000Hz at rated output

Signal To Noise Ratio

Phono: 86dB below 10mV input (A Weighted)

High Level: 96dB below rated output (A Weighted)

Rated Output Voltage

2.5V Unbalanced Outputs (Main)

5.0V Balanced Outputs (Main)

Maximum Voltage Output

8V Unbalanced

16V Balanced

Output Impedance

250 ohms Unbalanced

500 ohms Balanced

Input Impedance

Phono: 47k Ohms, 65pf

High Level: 22k Ohms Unbalanced

50k Ohms Balanced

Sensitivity for Rated Output

Phono: 4.5mV

High Level: 450mV Unbalanced

900mV Balanced

Maximum Input Signal

Phono: 50mV

High Level: 5V Unbalanced

10V Balanced

Voltage Gain

Phono to Tape/VCR Out: 40dB

Phono to Output (Main): 55dB

High Level to Tape/VCR Out: 0dB

High Level to Output (Main): 15dB

Tone Controls

Bass Control: ± 12 dB at 30Hz

Treble Control: ± 12 dB at 10,000Hz

Power Requirements

100 Volts 50/60Hz, 35 watts

110 Volts 50/60Hz, 35 watts

120 Volts 50/60Hz, 35 watts

220 Volts 50/60Hz, 35 watts

230 Volts 50/60Hz, 35 watts

240 Volts 50/60Hz, 35 watts

Note: Refer to the rear panel of the C45 for the correct voltage.

Overall Dimensions

Width is 17-1/2 inches (44.45cm)

Height is 6 inches (15.24cm) including feet

Depth is 16-1/2 inches (41.91cm) including the Front Panel and Knobs

Weight

21 pounds (9.53 kg) net, 35 pounds (15.88 kg) in shipping carton

TM1 AM/FM Tuner Module

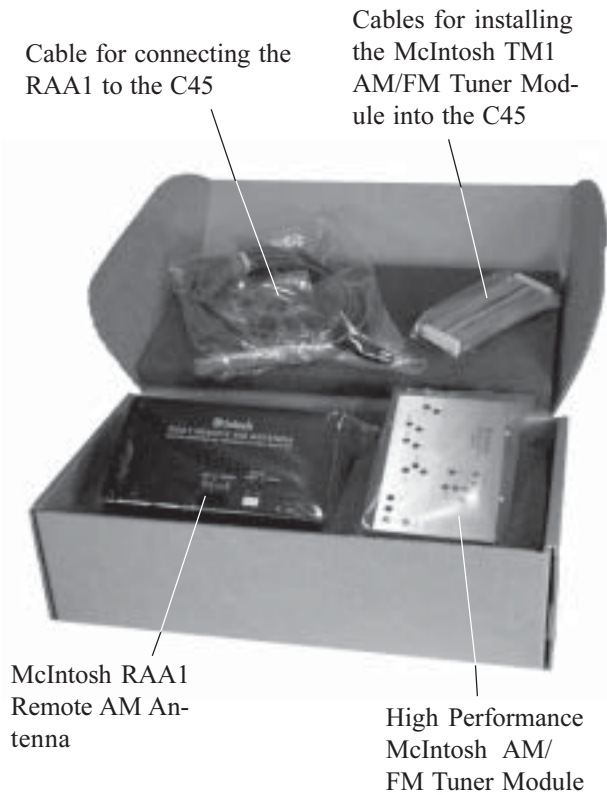

Introduction

The optional McIntosh TM1 AM/FM Tuner Module can be added to the C45 Audio Control Center for Radio Broadcast Reception. The TM1 delivers the same exceptional performance as the stand-alone McIntosh MR85 Tuner. The TM1 is available from your McIntosh Dealer and can be installed at any time, usually while you wait.

Performance Features

- **Special FM RF Amplifier**

Double-Diffused Metal Oxide Field Effect Transistor (DMOS-FET) RF amplifier increases sensitivity and Cross Modulation rejection.

- **External AM RF Amplifier and Antenna**

The TM1 includes a RAA1 Remote AM Antenna that contains an electrostatically shielded AM RF Amplifier Stage for maximum noise rejection. It can be located in a remote area, away from sources of interference and can be positioned for the best possible reception of even the weakest AM stations.

- **FM Stereo Auto Blend Circuitry**

An automatic variable stereo separation control circuit is used to reduce background noise when receiving weak stereo stations.

- **Preset Stations and Permanent Memory**

Nine AM and nine FM Station Presets, making it easy to listen to your favorite stations. Station Presets and Functions Modes are retained in Permanent Memory even when AC power is turned Off.

- **Alphanumeric Fluorescent Display**

The C45 Multi-function Front Panel Display indicates station frequency, station preset number, signal strength, stereo and broadcast band.

TM1 Table of Contents

Introduction	27
Performance Features	27
C45 Rear and RAA1 Top Panels	
Antenna Connections	28
How to Connect Antenna Components	29
How to Operate the Tuner	30
How to Assign Preset Stations	31
How to Optimize AM Reception	32
FM Specifications	34
AM Specifications	34

RAA1 Remote Antenna can be adjusted to a position for optimum reception of your favorite AM stations

Connects with supplied cable to the C45



AM ANT (Antenna) connector allows a McIntosh Remote Antenna to be connected



75ohm FM ANT (Antenna) connects to an external FM antenna or cable

How to Connect Antenna Components

1. Connect the Remote AM antenna by plugging the DIN connector of the supplied 3 conductor cable into the AM ANT, DIN socket on the back panel of the C45.

Note: If a longer length cable needs to be used between the C45 and the RAA1, use a 2 conductor shielded cable. Refer to page 4 for additional connection information.

2. Connect a 75 ohm coax cable from an FM antenna or cable system to the C45, 75 ohm FM ANT connector.

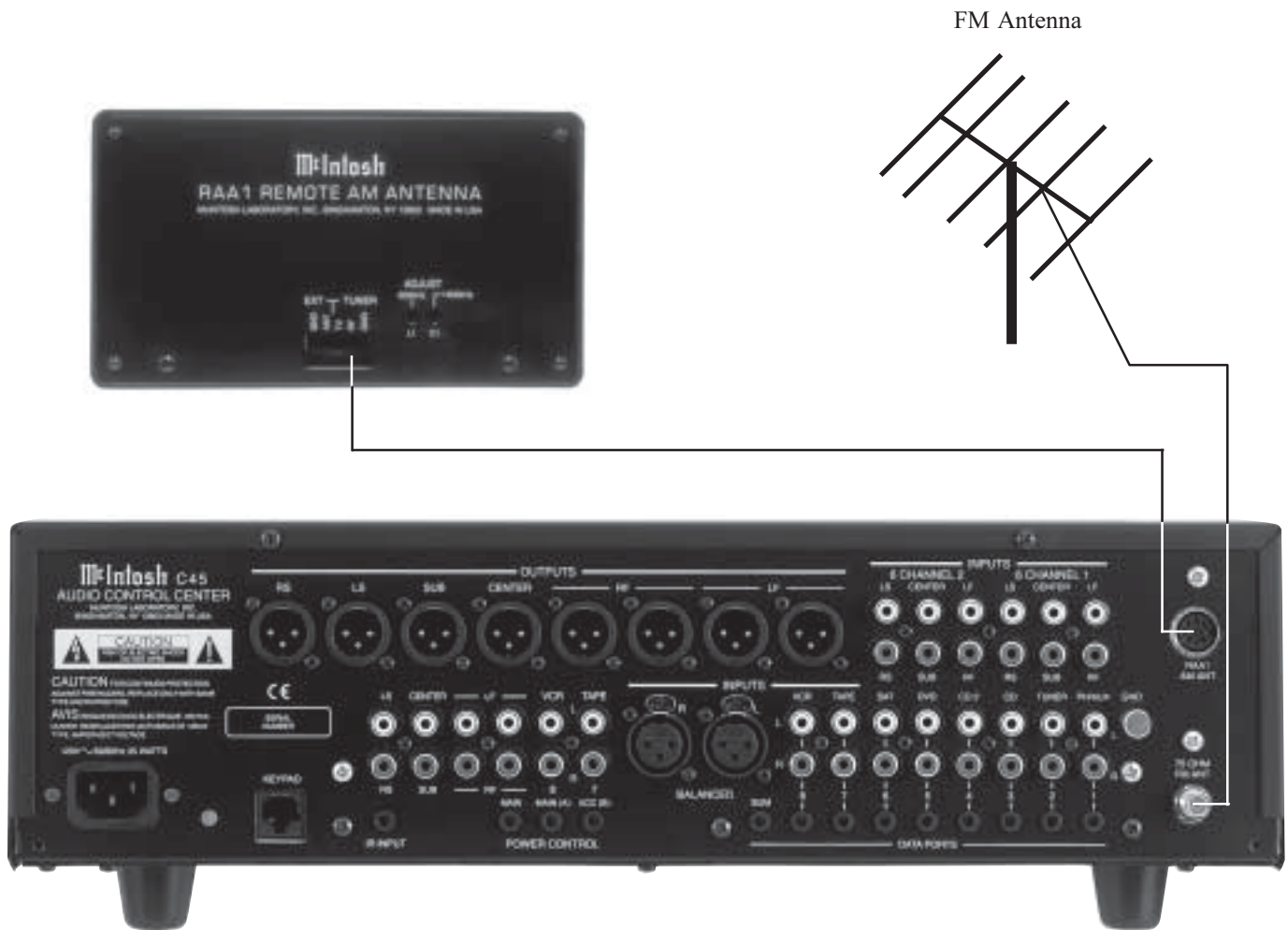

How to Operate the Tuner

The McIntosh C45 TM1 AM/FM Tuner Module incorporates an advanced design AM/FM Tuner with many desirable performance features to enhance your enjoyment of radio broadcasts. There are three methods of tuning AM/FM Broadcast Stations using the Front Panel Tune Push-buttons and four methods using the Remote Control. These tuning methods include Manual, Automatic Station Seek, Automatic Preset Review, Preset Selection and Direct Preset Number Access.

Notes: FM Broadcast Band Indications are in Megahertz in the US and Canada, and change frequency in 200kHz steps. For FM stations in various locations other than the US stations change in 50kHz steps. AM Broadcast Band Indications are in Kilohertz and change frequency in 10kHz steps.

1. Select TUNER FM or TUNER AM with the Front Panel INPUT Control or the Remote Control TUNER Push-button followed by the AM or FM Push-button. Refer to figures 42 & 43.
2. For Manual Station Selection, press the Front Panel TUNE(TRIM LEVEL) Up▲ or Down▼ Push-button.
3. For Automatic Station Seek, press and release the CHANNEL Up▲ or Down▼ Push-button on the Remote Control, to select stations.

Note: The Front Panel TUNE(TRIM LEVEL) Up▲ or Down▼ Push-button may also be used, however the tuning mode in setup needs to be changed to the SEEK Mode from the default setting of Manual TUNE. Refer to page 16 for additional information.
4. For Automatic Preset Review, press and release the REVIEW Push-button on the Remote Control. The C45 will stop on the next assigned Preset Station for approximately 5 seconds and proceed to the next Preset Station. When the REVIEW Push-button is pressed a second time, the Preset Review Mode will be cancelled and the current Preset station is available for listening.

Note: There first must be stations entered into Preset Memory for the Review Mode to function. Refer to "How to Assign Tuner Presets" for additional information.

5. For Preset Selection, press and release the NEXT▶▶▶ or BACK◀◀◀ Push-button on the Remote Control, to select a Preset Station.

Note: The Front Panel TUNE (TRIM LEVEL) Up▲ or Down▼ Push-button may also be used, however the tuning mode in setup needs to be changed to the PRESET Mode from the default setting of Manual TUNE. Refer to page 16 for additional information.

6. For Direct Preset Number Access, select the Tuner AM or FM Input using either the Front Panel INPUT Control or press the TUNER and AM or FM Push-buttons followed by the numbered push-button for the desired Preset.



Figure 43



Figure 42

How to Assign Tuner Presets

The C45 AM/FM Tuner Module (TM1) allows for presetting radio stations into memory. Refer to figure 44 and perform the following the below steps to enter stations:

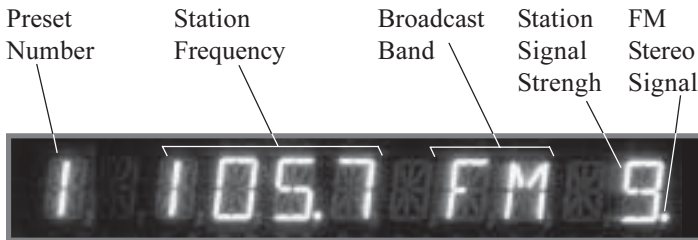

Figure 44

1. Select either the AM or FM Broadcast Band using either the INPUT Control or the Remote Control AM or FM Push-button. Refer to figures 42 and 43.
2. Press the Front Panel TUNING Up▲ or Down▼ Push-button, or the CHANNEL Up▲ or Down▼ Push-button on the Remote Control, to select a station.
3. Momentarily press and release the Front Panel ENTER Push-button. The Front Panel Alphanumeric Display will indicate 1 AVAILABLE, which is the first of 9 Preset Numbers that can be assigned. The Station that is about to be entered into memory may also assigned to a different Preset Number (2-9) by rotating the INPUT (PRESET) Control to select the desired Preset Number. Refer to figures 42 and 45.

Note: Presets are automatically assigned in order from 1 to 9 unless a different Preset Number is selected



Figure 45

4. Press and release the Front Panel ENTER Push-button a second time to store the Preset into memory. The just entered Station Preset Selection will be assigned Preset Number 1 which is displayed on the left side of the Front Panel Alphanumeric. Refer to figures 42 and 44.

Note: A chart on page 32 has been provided to record the stations entered into Preset Memory.

5. Assign additional station Presets by performing steps 1 through 5 until a total of 9 AM and 9 FM Station Presets have been assigned. Each time you assign an additional Preset Number, the Front Panel Alphanumeric Display will indicate the number of the next available Preset.

Note: If all 9 Presets are assigned and the ENTER Push-button is pressed, the display will indicate the station selected for Preset Number 1.

6. To verify the Station Preset(s) just entered into memory, press the the NEXT▶▶ or BACK◀◀ Push-button on the Remote Control to cycle through and confirm your preset assignments.

Note: Pressing the REVIEW Push-button on the Remote Control will also allow reviewing the stored Presets.

How To Clear an Assigned Station Preset

1. Press ENTER Push-button.
2. Rotate the Front Panel INPUT Control to select the Preset Number of the Station to be removed from memory.
3. Press and Hold the ENTER Push-button for approximately 3 seconds until the Front Panel Alphanumeric Display indicates the number of the Preset followed by the word CLEARED. Refer to figure 46.

Note: If you wish to replace an already assigned Station Preset with another radio station, it is not necessary to clear the Preset first, just enter in the new station for that Preset. The new station will automatically replace the previously assigned station.



Figure 46

4. To clear any additional Station Presets perform steps 1 through 3 again.

How to Optimize AM Reception

The McIntosh RAA1 Remote AM Antenna is designed to provide the best in AM Reception especially if the C45 is located in a noisy reception area. Locate the RAA1 away from all electronic and electrical interference sources. Rotate the AM Antenna to reduce interference and receive maximum signal strength.

Notes: The RAA1 Remote AM Antenna of the TMI has been factory adjusted for optimum reception in a typical urban location. If you wish to customize the AM Antenna for the best possible performance in your location, have your dealer perform the two adjustment operations listed below. An additional long wire AM antenna or external ground can be connected to the GND and ANT terminals if desired.

1. Tune to a weak AM station near 600kHz on the AM band. Using an appropriate **NON - METALLIC** tool, adjust the 600kHz Transformer L1 for maximum signal strength. Refer to figure 47.
2. Tune to a weak AM station near 1400kHz on the AM band. Using an appropriate **NON - METALLIC** tool,

- adjust the 1400kHz Trimmer Capacitor C1 for maximum signal strength.
3. Repeat steps 1 and 2 until no further improvements can be obtained.



Figure 47

FM and AM Station Presets			
Preset Number	Frequency	Call Letters	City
FM 1			
FM 2			
FM 3			
FM 4			
FM 5			
FM 6			
FM 7			
FM 8			
FM 9			
AM 1			
AM 2			
AM 3			
AM 4			
AM 5			
AM 6			
AM 7			
AM 8			
AM 9			

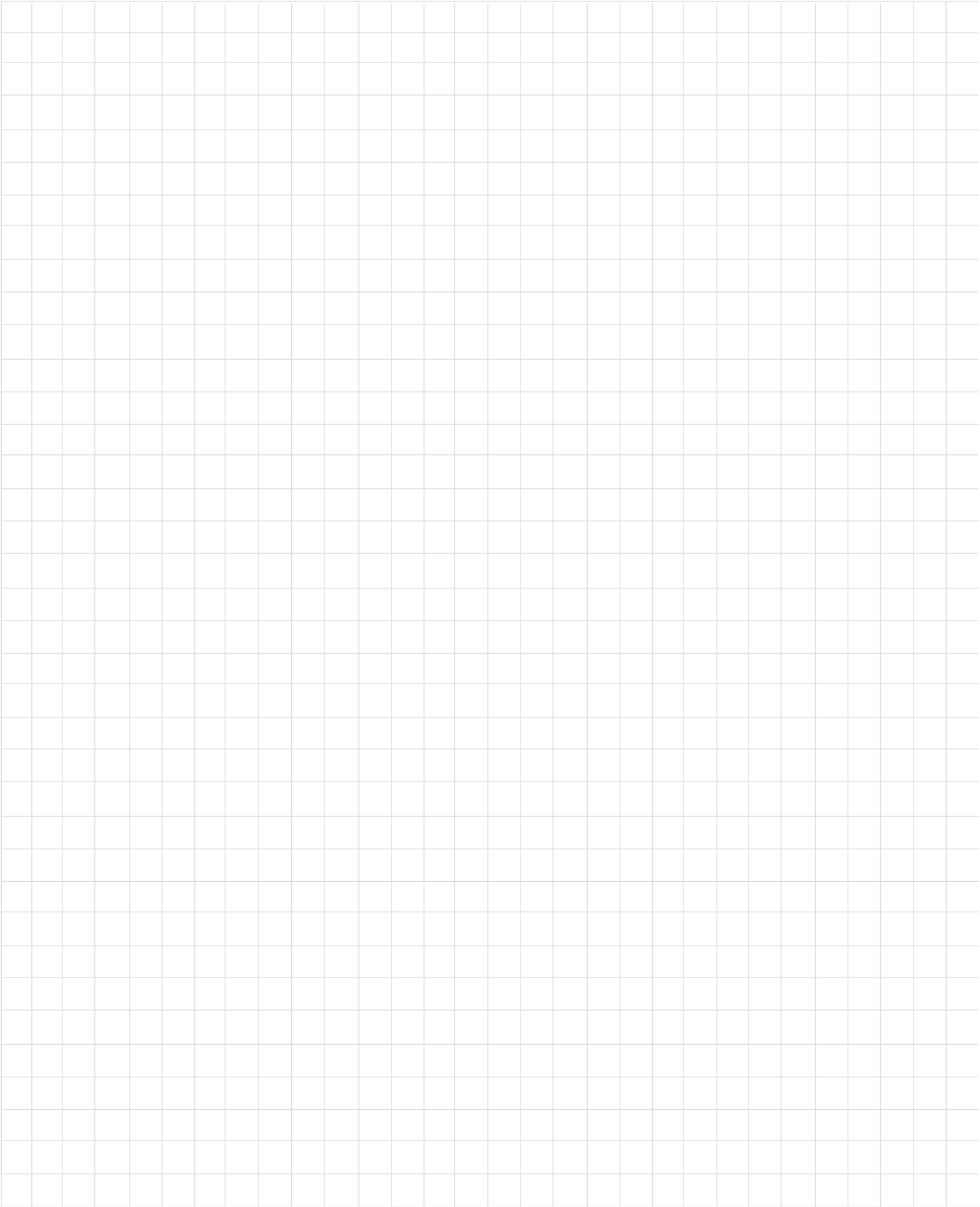

FM Tuner Specifications

Useable Sensitivity

14dBf which is 1.4uV across 75 ohms

50dB Quieting Sensitivity

Mono: 19dBf which is 2.4uV across 75 ohms

Stereo: 35dBf which is 15uV across 75 ohms

Signal To Noise Ratio

Mono: 75dB

Stereo: 70dB

Frequency Response

Mono: + 0, - 1dB from 20 to 15,000Hz

Stereo: + 0, - 1dB from 20 to 15,000Hz

Harmonic Distortion

Mono: 0.3% at 100Hz

0.3% at 1,000Hz

0.3% at 10,000Hz

Stereo: 0.45% at 100Hz

0.45% at 1,000Hz

0.65% at 10,000Hz

Intermodulation Distortion

Mono 0.25%

Stereo 0.45%

Capture Ratio

1.2dB

Alternate Channel Selectivity

75dB

Spurious Response

100dB

Image Response

75dB

RF Intermodulation

65dB

Stereo Separation

45dB at 100Hz

45dB at 1,000Hz

35dB at 10,000Hz

SCA Rejection

65dB

AM Tuner Specifications

Sensitivity

20uV External Antenna Input

Signal To Noise Ratio

48dB at 30% modulation

58dB at 100% modulation

Harmonic Distortion

0.5% maximum at 50% modulation

Frequency Response

50Hz to 6kHz NRSC

Adjacent Channel Selectivity

45dB minimum IHF

Image Rejection

65dB minimum from 540 to 1600kHz

IF Rejection

80dB minimum

Packing Instructions

In the event it is necessary to repack the equipment for shipment, the equipment must be packed exactly as shown below. It is very important that the four plastic feet are attached to the bottom of the equipment. This will ensure the proper equipment location on the bottom pad. Failure to do this will result in shipping damage.

Use the original shipping carton and interior parts only if they are all in good serviceable condition. If a shipping carton or any of the interior part(s) are needed, please call or write Customer Service Department of McIntosh Laboratory. Please see the Part List for the correct part numbers.

Quantity	Part Number	Description
1	033838	Shipping carton only
4	033837	End cap
1	033836	Inside carton only
1	033725	Top pad
1	034194	Bottom pad
1	034037	Inner carton pad
4	017218	Plastic foot
4	100159	#10-32 x 3/4" screw
4	104083	#10-7/16" Flat washer

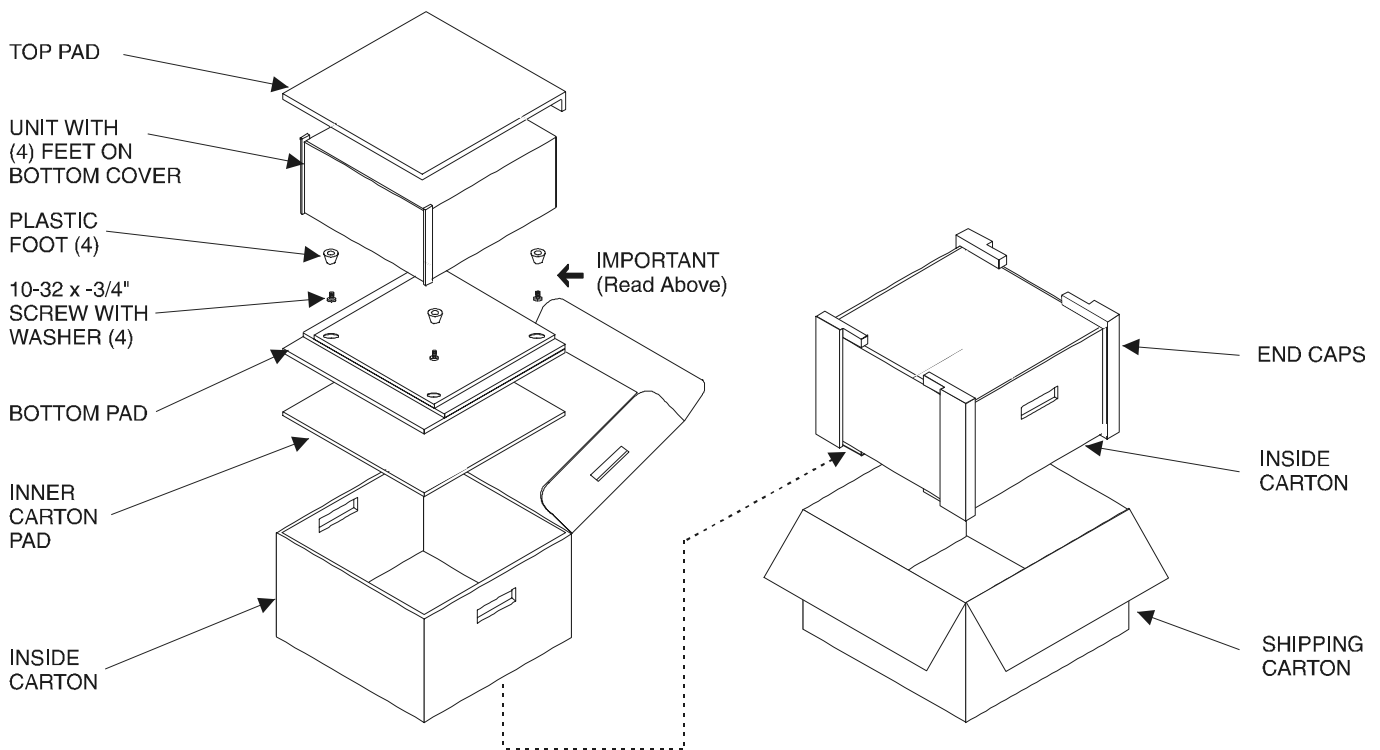



McIntosh Laboratory, Inc.
2 Chambers Street
Binghamton, NY 13903

The continuous improvement of its products is the policy of McIntosh Laboratory Incorporated who reserve the right to improve design without notice.
Printed in the U.S.A.

McIntosh Part No. 040887